

# Installation instruction Bluetooth hands free kit FISCON

„Basic-Plus“	article-ID	36431
	head unit	RNS-E BNS 5.0
	head unit	Concert (A4 8K, A5 8T, Q5 8R)** Symphony (A4 8K, A5 8T, Q5 8R)**

„Basic“	article-ID	36430
	head unit	Chorus II Concert II Symphony II

„Basic“	article-ID	36430-1
	head unit with BNS 4.X navigation	Chorus II Concert II Symphony II

„Basic“	article-ID	36429
	head unit	Chorus III (Doppel DIN) Concert III (Doppel DIN) Symphony III (Doppel DIN)
	head unit	RNS-E BNS 5.0

Audi A3 (8P) Sportback, Cabrio  
Audi A4 (8E) B6, B7  
Audi A6 (4B)\*  
Audi A8 (4D)\* from SW-index 1.65  
Audi TT (8J) Roadster, Coupe

Audi A4 (8K)  
Audi A5 (8T)  
Audi A5 (8F - Cabrio from SW-index 1.69)  
Audi Q5 (8R)

\*from model 2000

\*from software index 1.43

[www.kufatec.de](http://www.kufatec.de)

# Content

FISCON _____	01
Safety Instructions _____	02
Installation instruction Audi A3 (8P), A4 (8E), A6 (4B), A8 (4D), TT (8J) _____	03
Installation instruction Audi A4 (8K), A5 (8T), A5 (8F), Q5 (8R) _____	05
Control elements/ operation menu _____	08
FISCON Setup through mobile phone _____	09
Operating instruction _____	10
FAQ _____	14

---

## Bluetooth Hands free kit versions

operating by...	Basic	Basic-Plus
Head unit	no	yes
Multifunctional steering wheel	yes	yes

Vehicles not equipped with multifunctional steering wheel (MFSW) do not support the guided menu displayed in the passenger information system (cluster). The system will still display the caller (depends on mobile phone) into the cluster. In case the caller is not stored by name the number will be displayed in the cluster. Without MFSW you need to operate the system by using the mobile phone.

## Bluetooth Hands free kit

- **Complete Integration** into the Infotainment system of the vehicle.
- Operation by Radio Concert, Symphony (A4 8K, A5 8T, A5 (8F), Q5 8R) as well as head unit RNS-E, BNS 5.0 (only for Basic-Plus version)
- Operation by multifunctional steering wheel - MFSW (if available)
- **A2DP Audiostreaming** in order to transfer music to the Infotainment system of the vehicle
- Numerous Setup possibilities:
  - **Microphone adjustment** in order to optimize the voice quality
  - **Volume control** regarding A2DP, Conversation, Ring tone ...
  - Setting of national **language**
- Use of the following telephone **operations**:
  - Access to the **phonebook** (depends on mobile phone, display through the cluster)
  - Placing, answering as well as ending calls
  - Volume control
- Easy installation, No cutting of wires necessary
- **Unlimited Software Updates**

## Scope of delivery

- Bluetooth interface
- Wiring
- Microphone
- Manual

**NOTE:** Regarding to the country of destination the FISCON interface will support different types of languages (from FISCON software index 1.46).

## safety Instructions

Congratulations to your new Hands free kit.  
Thank you for choosing a product of Kufatec GmbH.

Please take note that the installation can only be done by vehicles which are using a 12V battery. In particular trucks, all-terrain vehicles and commercial diesel cars including taxis are running often with 24V batteries and an installation is not possible in these kind of vehicles.

Before starting the installation the battery of the vehicle has to be disconnected!

Take care to ensure no devices are affected or damaged that are relevant to security or safe operation of the vehicle.

This unit is only for use in the following vehicles. Only connections described within this instruction guide are allowed or required to use for installation.

For damage impact caused by faulty installation, unsuitable connections inappropriate vehicles Kufatec GmbH assumes no liability.

We advise you that these units process datas out of the CAN - protocol from the vehicle. As the supplier of this device we don't know the overall system you are working with. If our device causes damage due to other changes made by to the vehicle Kufatec GmbH assumes no liability.

If the car manufacturer's don't agree with the installation of our device by reason of warranty the Kufatec GmbH assumes no liability. Please check conditions and warranty before you begin the installation.

Kufatec GmbH supplier reserves the right to change the device specifications without notice.

**NOTE:** The road traffic has to have your full attention.  
Telephone operations should only be done by suitable traffic and weather situations.  
The volume need to be set that you are still able to realise acoustic warn signals  
(Police, fire brigade).

**NOTE:** Before installing the FISCON system you need to check whether the car is retrofitted with a video interface not developed by Kufatec GmbH. In case a non-Kufatec video interface is fitted we are not able to guaranty the absolute operation of the FISCON system. You may need to remove the non-Kufatec video interface.

In order to achieve a proper communication you need to keep installation sequence as follows:

**Vehicle** → **FISCON** → **Multimedia (Kufatec Multimedia , TV in motion)**  
**Adapter**

The FISCON system can be used in combination with the **Kufatec** Multimedia Adapter **(from SW 2.53)**. Furthermore you need to remove any **mobile phone preparations**, which are communicating with the CAN Bus system of the vehicle!

# Installation instruction - A3 (8P), A4 (8E), A6 (4B), A8 (4D), TT (8J)

Please remove the head unit using suitable tools, after removing disconnect the necessary wiring.

With a plug & play connection you will complete the fitting of the hands free kit. Please see scheme below. Unlock the connection and put the delivered wiring between the head unit and the connector coming from the vehicle.

Wire the loom for the interface connection towards the glove box. Find a suitable location for the interface box within the vehicle. Make sure you will reach the interface at any time (regarding to software updates).

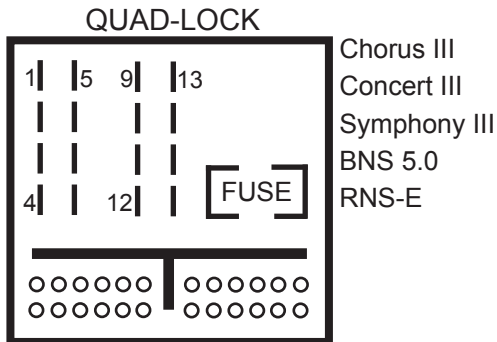

image 1

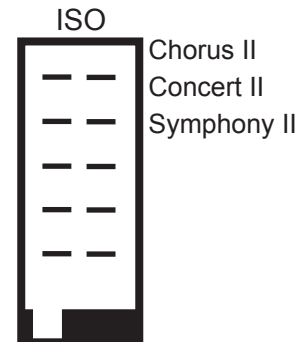

image 2

The connector for the microphone has to be wired along the A-column towards the sun shield.  
**NOTE:** Regarding to the voice quality do not fit the microphone covered inside the interior light.

**ATTENTION:** Does the vehicle have airbags fitted along the A-column it is essential to wire the loom for the microphone **BEHIND** the airbag. Wire the loom without putting tension on it.

## Note for vehicles fitted with Navigation BNS 4.X

In case of factory fitted navigation BNS 4.X the looms for TEL+, TEL- as well as mute needs to be connected to the 20-pole connector of the navigation device.

Wire the looms towards the navigation device in the trunk of the vehicle.



Connection 20-pole Mini-Iso.

- TEL+ (NF+) - PIN 16
- TEL - (NF-) - PIN 19
- TEL Mute - PIN 17

Connection navigation device

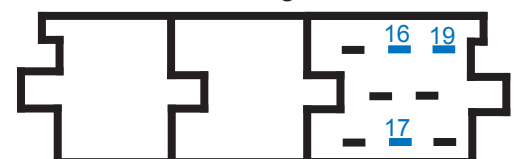



## Installation instruction - A4 (8K), A5 (8T), A5 (8F), Q5 (8R)

Please remove the cover of the display by using suitable tools in order to avoid damages (image 1). Disconnect the connection for airbag.



image 1



image 2



image 3

Please remove the vent (image 2) as well as the climate control (image 3) by using suitable tools.

Loose the 4 screws of the head unit and remove it. After removing disconnect the necessary wiring.

With a plug & play connection you will complete the fitting of the hands free kit. Please see scheme below. Unlock the connection and put the delivered wiring between the head unit and the connector coming from the vehicle.

Wire the loom for the interface connection towards the glove box. Find a suitable location for the interface box within the vehicle. Make sure you will reach the interface at any time (regarding to software updates).

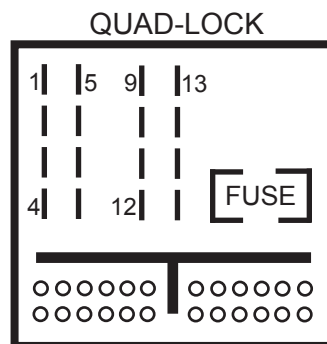

The connector for the microphone has to be wired along the A-column towards the sun shield.  
**NOTE:** Regarding to the voice quality do not fit the microphone covered inside the interior light.

**ATTENTION:** Does the vehicle have airbags fitted along the A-column it is essential to wire the loom for the microphone **BEHIND** the airbag. Wire the loom without putting tension on it.

## Coding A4 (8K), A5 (8T), A5 (8F), Q5 (8R)

After installation you need to code the system to telephone. Please contact an Audi VW dealer or workshop with diagnostic system.

## Coding Diagnostic interface address 19

In order to code the vehicle system you need to choose the **Self-Diagnosis**. Please complete the coding step by step like shown on images below.

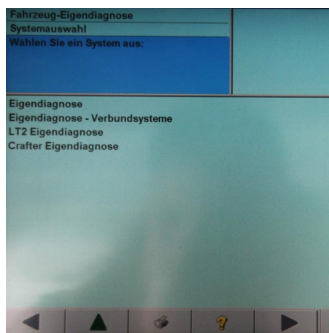

Vehicle Self-Diagnosis

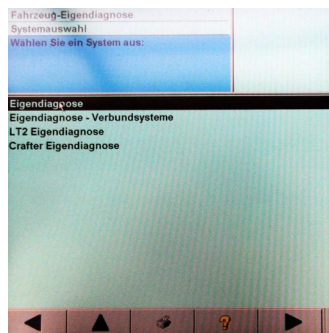

Self-Diagnosis

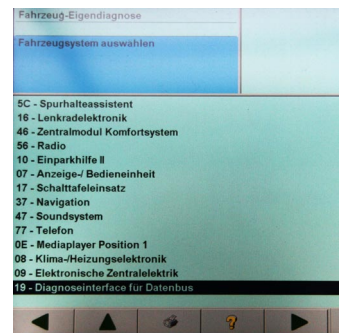

select address 19  
(Diagnostic interface)

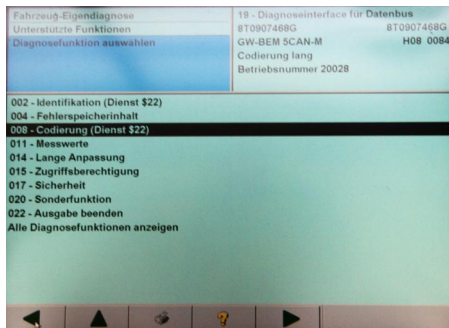

008 - Coding

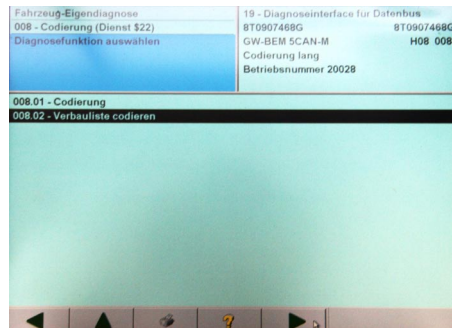

008.02 - coding part list

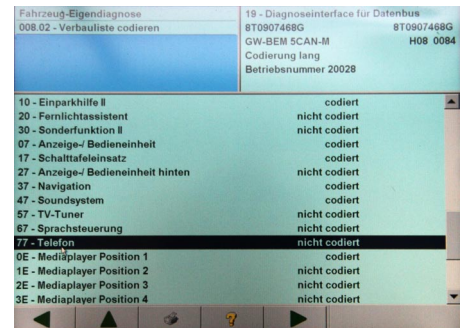

77 - select Telephone

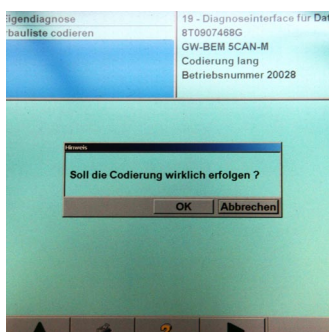

Confirm coding with OK

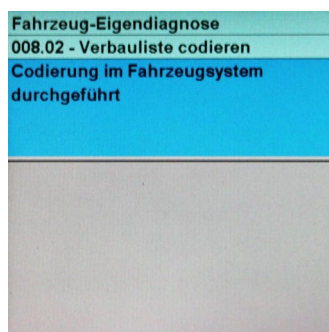

Coding completed

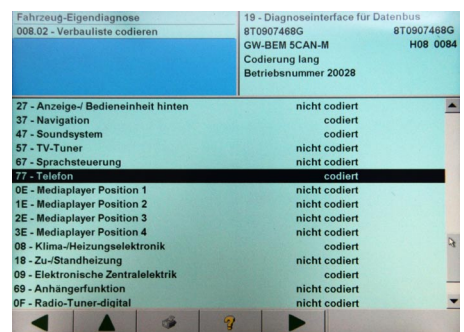

Telephone

## Coding A4 (8K), A5 (8T), A5 (8F), Q5 (8R)

### Coding Radio address 56

You need to select the menu **Self-Diagnosis** again.

Please complete the coding step by step like shown on images below.

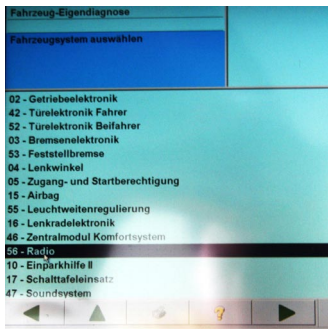

Address 56 - Radio →

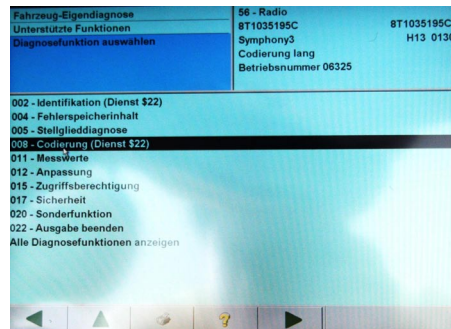

008 - Coding →

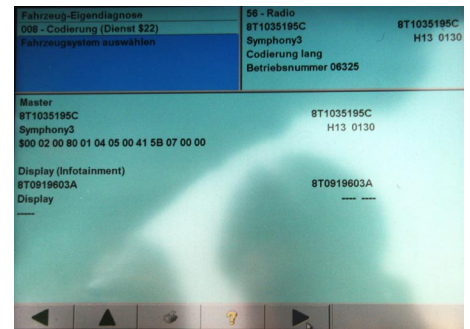

select Master →

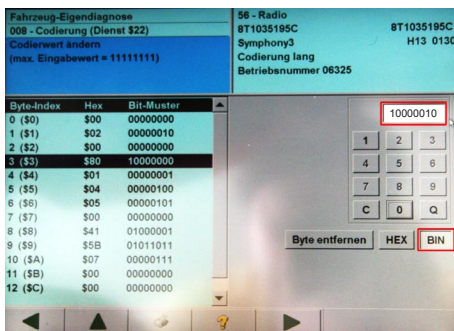

select Byte 3  
select BIN (Binär)  
Enter value **10000010** - Confirmation

## Coding sound system Address 47

Only for vehicles equipped with Audi sound system, Bang & Olufsen sound system!

Address 47 - Byte 0 → Bit 0 needs to be set to 1  
Bit 1 needs to be set to 0

## PIN Configuration FISCON interface

PIN Configuration in order to connect the FISCON system to after market radios.

You need to connect in addition the following PIN's to the after market radio (Blue marked figures).

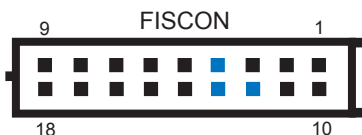

- 4 - Mute
- 8 - Ground
- 9 - +12V
- 12 - NF1 -
- 13 - NF1 +
- 17 - CAN-Low
- 18 - CAN-High

For damage impact caused by faulty installation, unsuitable connections Kufatec GmbH assumes no liability.

## Control elements

### Multifunctional steering wheel

[A4 B7, TT 8J, A3 8P, A4 8K, A5 8T, A5 8F, Q5 8R]

By pushing the **MODE** button on MFSW you will reach the menu of the hands free kit. By using the **SCROLL** you will select the single options as well as complete the different settings.



### Multifunctional steering wheel

[A4 B6, A6 4B, A8 4D]

By pushing the „<“ - button you will reach the phone menu. By using the arrow buttons „^“ - „v“ you will choose the single options.

By using the „>“ - button you will confirm the single selections. In order to leave the menu please select the button „<“.

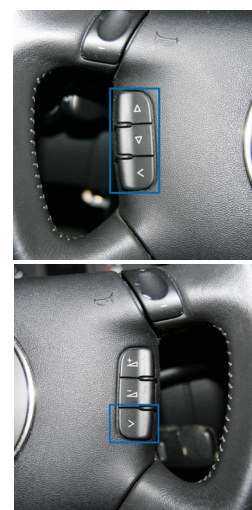

## Fiscon menu (limited A4 8K, A5 8T, A5 8F, Q5 8R)

DIS	Description
PHONEBOOK	Access to the phonebook of the mobile phone. The phonebook feature is not supported by all mobile phones. Does your mobile phone support the phonebook feature you will have access to the phonebook. Phonebooks that have a large number of entries can take quite a long time to synchronise. Please avoid cancellations during synchronisation. The phonebook feature is limited to 1000 phonebook entries.
DIALLED NUMBERS	By choosing the menu <b>DIALLED NUMBERS</b> you are able to select these telephone numbers you dialled before (if supported from mobile phone).
ACCEPTED CALLS	By choosing the menu <b>ACCEPTED CALLS</b> you are able to select these telephone numbers you accepted before (if supported from mobile phone).
MISSED CALLS	By choosing the menu <b>MISSED CALLS</b> you are able to select these telephone numbers which tried to call you but you didn't accept (if supported from mobile phone).
A2DP	By choosing the menu <b>START A2DP</b> the system will have access to the music files stored on the mobile phone (if supported from mobile phone). By using the MFSW you can select the single tracks (NEXT TRACK, PREVIOUS TRACK). By choosing the menu <b>STOP A2DP</b> the music playback will be stopped.
MICROPHONE ADJUSTMENT	By choosing the menu <b>MICROPHONE ADJUSTMENT</b> you will have the possibility to boost the signals of the microphone from 0DB up to 30DB.

## FISCON Setup through mobile phone



You are able to complete Interface settings by using your mobile phone.

**Condition** is that the mobile **transmits** the number to the head unit.

In case your mobile doesn't support that feature you need to use a phone which does.

### Setup

- Establish a Bluetooth connection between your telephone and the FISCON unit.
- Use the following setup - Code: **\*582#xxyy**
- Please see the table below for the values **xx** as well as **yy**.

Function	<b>xx</b>	<b>yy</b>	Example
Volume telephone	10	(01-15)	*582#1009
Volume ring tone	11	(01-15)	
Volume prompt	12	(01-15)	
Volume A2DP	13	(01-63)	*582#1346
Microphone adjustment	14	(01-15)	
Software update	20	25	
Factory settings	21	77	
Language setting	30	(00-07)	

### Language - 30

**00** = Vehicle language

**04** = Italian

**01** = German

**05** = French

**02** = Englisch

**06** = Dutch

**03** = Spanisch

**07** = Portuguese

- After entering the values please press the **Call** - button.

# Operating instruction „Basic-Plus“ - RNS-E

The following operating instruction is also valid for the head unit **BNS 5.0** as well as Radio **Concert**, **Symphony** for Audi **A4 8K**, **A5 8T**, **A5 8F**, **Q5 8R** (certain variations in consequence of original operating as well as range of functions).

Does the vehicle not have factory fitted Hands free kit image 4 will appear by choosing the **TEL** button. As soon as the installation as well as the coding has been finished and the interface is connected the telephone screen will display image 5.



Image 4



Image 5

## Pairing

1. Press the **TEL** button on RNS-E Radio.
2. Make sure the Bluetooth feature is turned on.
3. Start the pairing procedure on your mobile phone.
4. When prompted for a passkey, enter **1234** on your mobile phone.

Once pairing is complete, you should see image 3 on the RNS-E radio. You will see the network provider's name as well as the coverage if supported from mobile phone (please check compatibility list).

You may pair up to 5 different mobile phones.



Image 6

In case you would like to pair the sixth mobile phone you need to restore the factory settings. In case of activating the factory settings all stored mobile phones get lost.

**NOTE:** At the time of activating the factory settings you need to cancel any Bluetooth connection to the FISCON system. After choosing the **SETUP** button please complete procedure shown on image 7 - 9.



Image 7



Image 8

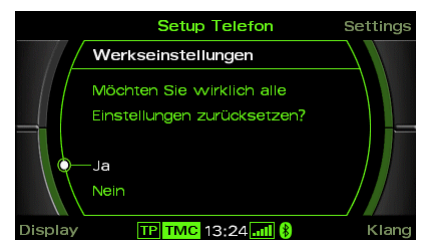

Image 9

# Operating instruction „Basic-Plus“ - RNS-E

## Incoming calls

An incoming call will cause system operations as follows:

1. Mute activation - The ring tone of the mobile will be generated.
2. Display of the caller name (depends on mobile phone). In case the caller is not stored by name the number will be displayed in the cluster.

## Answer a call



In order to answer a call please select the button **Annehmen** (answer).

Would you like to end a call press the button **Auflegen** (end).

Image 10

## Answer a second call



In case of receiving a second call during an already started conversation the screen will show image 11.

By using the knob you are able to switch to the second call as well as ignore the second call.

Image 11

## Placing calls

Depending on your mobile phone you have got several possibilities to place a call.

## Dial plate

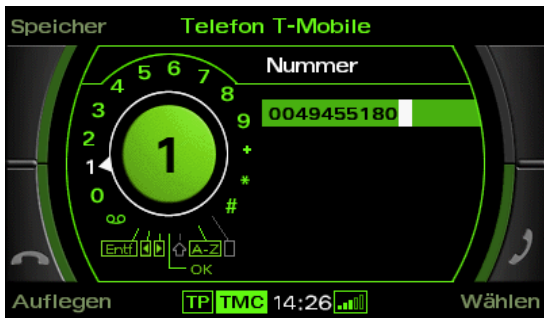

1. Press **TEL** button.

2. By using the knob you are able to enter the telephone number you are going to call.

Image 12

# Operating instruction „Basic-Plus“ - RNS-E

Dialed numbers (If supported by mobile phone)



1. Press **TEL** button.
2. Press **Speicher** button.
3. By choosing the menu item **Dialed numbers** you are able to call a telephone number you dialed before.

Image 13

You may also dial numbers stored under the following:

- „Accepted calls“ (If supported by mobile phone) as well as
- „Missed calls“ (If supported by mobile phone).

## Phonebook

**Note:** The phonebook feature is not supported by all mobile phones. Does your mobile phone support the phonebook feature you will have access to the phonebook.

The phonebook feature is limited to 1000 phonebook entries.

**Note:** Phonebooks that have a large number of entries can take quite a long time to synchronise. Please avoid cancelations during synchronisation.

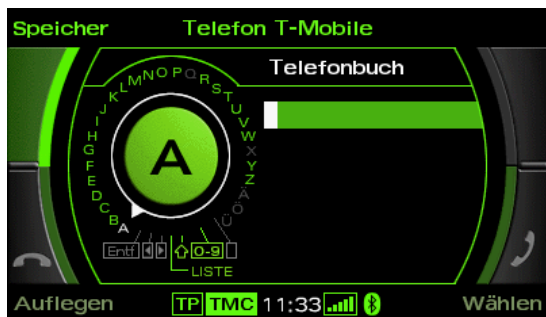

1. Press **TEL** button.
2. Press **Speicher** button.
3. By choosing the menu item **Phonebook** you are able to call a telephone number stored in your phonebook.

Image 14

**Note:** By using the **scroll** - button in a **fast** way you will get to the next initial letter of the phonebook.

## Search contact



1. Press **Phonebook**.
2. Press **Eintrag suchen**.
3. By using the knob you are able to search for contacts.

Image 15

# Operating instruction „Basic-Plus“ - RNS-E

## A2DP Audiostreaming

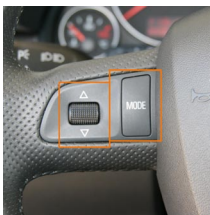

By using the MFSW you will select the menu **A2DP**. By choosing the menu **START A2DP** the system will have access to the music files stored on the mobile phone (if supported by mobile phone). By using the scroll you can choose the single files.

For vehicles without MFSW you need to select the music files through the mobile phone. As soon as you start playing music on your mobile phone it will be transferred to the speakers of the vehicle.

By choosing the menu **STOP A2DP** the music playback will be stopped.

**Note:** In case of Audi A4 8K, A5 8T, A5 8F, Q5 8R you need to start the A2DP function from your mobile phone.

## Enter Bluetooth PIN

In case you want to change the Bluetooth PIN please press **SETUP** as well as **Telephone settings**. Please complete procedure shown on image 13 - 15. By using the knob you are able to enter and store a new Bluetooth PIN.



Image 13



Image 14



Image 15

## Enter Mailbox number

Press **SETUP** and choose the menu item **Mailbox number**. Now you are able to enter your personal mailbox number (Image 16).



Image 16



Image 17

---

## FAQ

Why does not pop up the phonebook on the screen of the head unit?

- The phonebook feature is not supported by all mobile phones. Please check compatibility list!
- Phonebooks that have a large number of entries can take quite a long time to synchronise.

I don't have any access to the phone menus like „Dialed numbers“, „Accepted calls“, „Missed calls“.

- These feature are not supported by all mobile phones. Please check compatibility list!
- The system need to be coded specific to the radio as well as vehicle (see coding page 3, 5, 6).
- Guided menu through the cluster just available for vehicles with multifunctional steering wheel.

The FISCON system won't be accepted by the vehicle.

- In case a non-Kufatec video interface is fitted we are not able to guaranty the absolute operation of the FISCON system.
- Any mobile phone preparations which are communicating with the CAN Bus system of the vehicle have to be removed!
- The system has to be coded specific to the radio as well as vehicle (see coding page 3, 5, 6).
- After coding you need to complete a RESET of the headunit RNS-E.

No number of callers will be displayed in the cluster (Audi A4 8E, A6 4B).

- The cluster has to be coded (see coding page 3)

I'm not able to operate the hands free kit by using the buttons of the head unit RNS-E / BNS 5.0.

- Operation by using the original buttons of the RNS-E / BNS 5.0 head unit only available with FISCON version „Basic Plus“.

I do not have the guided menu within the cluster.

- Guided menu through the cluster just available for vehicles with multifunctional steering wheel.
- For vehicles not equipped with MFSW you need to operate the hands free kit by mobile phone.
- The system need to be coded specific to the radio as well as vehicle (see coding page 3, 5, 6).

Why is the DIS changing the display continuously?

- The vehicle is already equipped with an hands free kit. This hands free kit has to be removed.

Why does the mute function cut of continuously?

- The vehicle is already equipped with an hands free kit. This hands free kit has to be removed.